

HUD-Wedge PVB

■ 工作原理

通过放置在仪表台上的投影仪,将汽车的一些运行信息投影到玻璃上,成像在驾驶员眼睛正前方约2-3m的位置(正好在引擎盖的上方)

■ 主要优点

- ✓ 减少驾驶员低头看仪表盘的次数, 以便时时观察路况;
- ✓ 提高对外界突发状况的反应速度;

■ 主要应用

- ✓ 夹层前挡玻璃

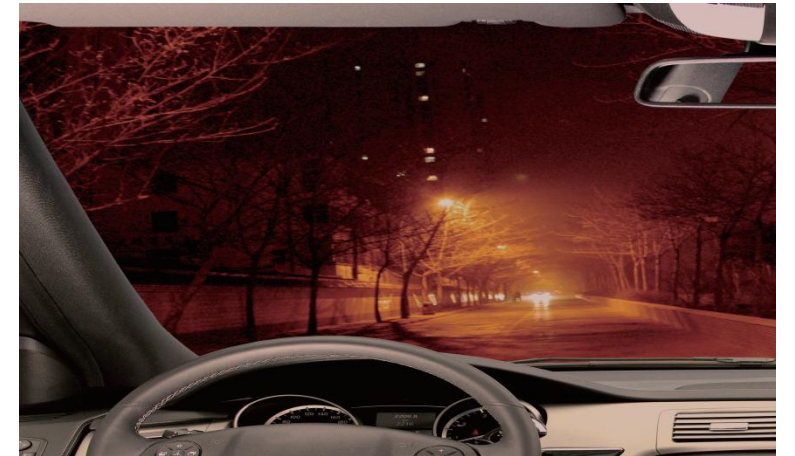
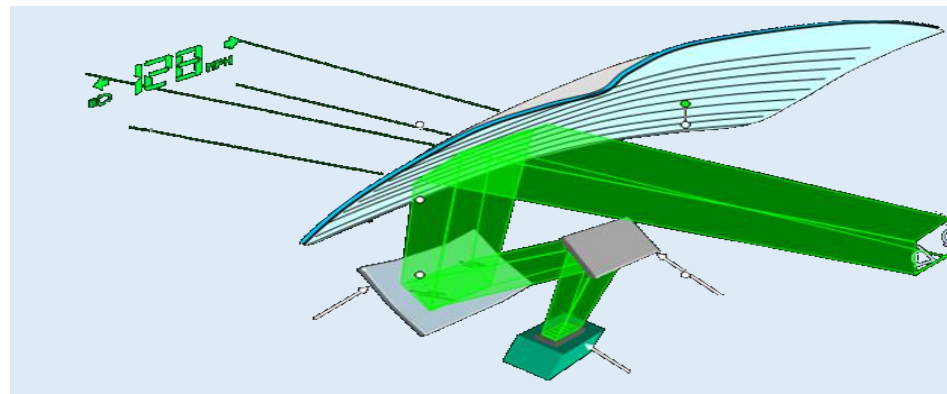

HUD-Wedge PVB

■ Principle

The image with the information been project on the windshield by the projector installed on the dashboard. And the Image just on the view of driver during he see the road.

■ Advantage

- ✓ No need to look down and see the information on dashboard
- ✓ Increased the reaction speed if something happed





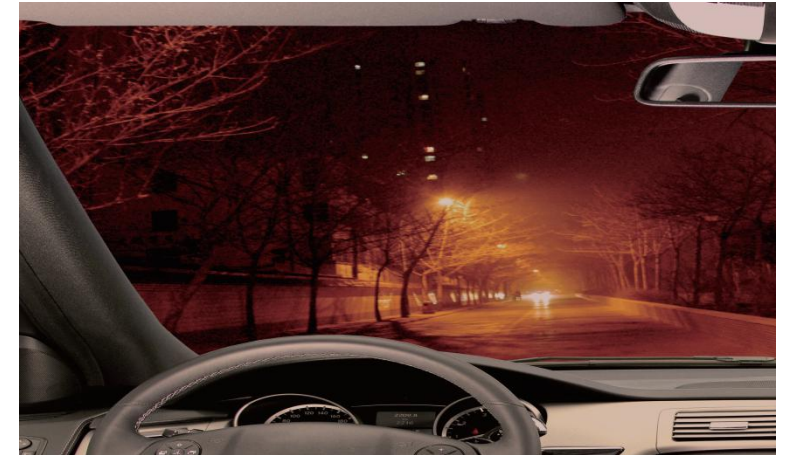
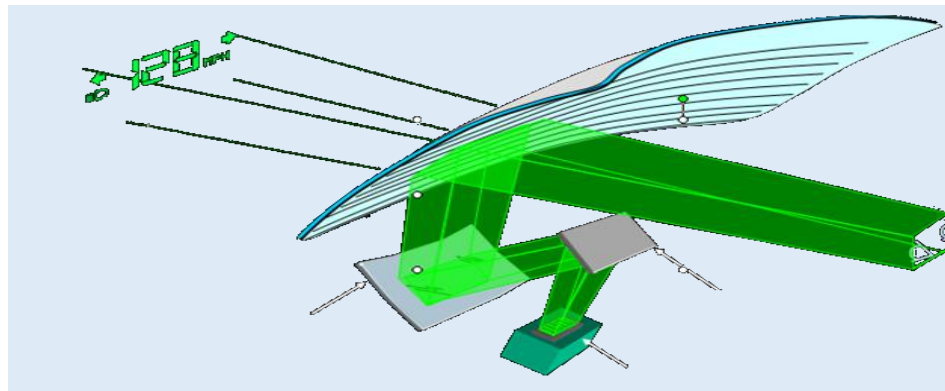



■ Used on





- ✓ Windshield



HUD-Wedge PVB

■ 实绩/Application

Customer	Model	Picture
	ATS	
	新君越 /La Crosse	
	SRX	
	A6L	
	帝豪 /EMGRAND	

Customer	Model	Picture
	NEW X3	
	新CX-5	开发中
	新雅阁	开发中
	XE	开发中